



■ Vers. 009



■ Vers. 018+481



■ Vers. 016+029+073



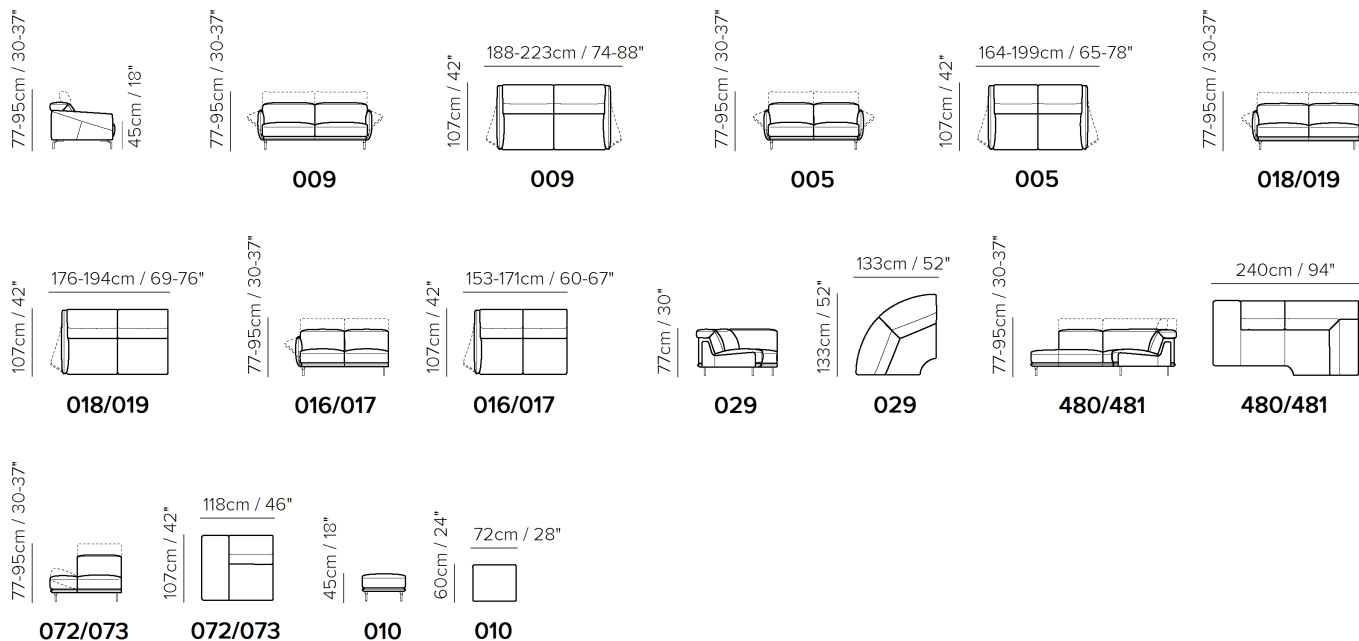

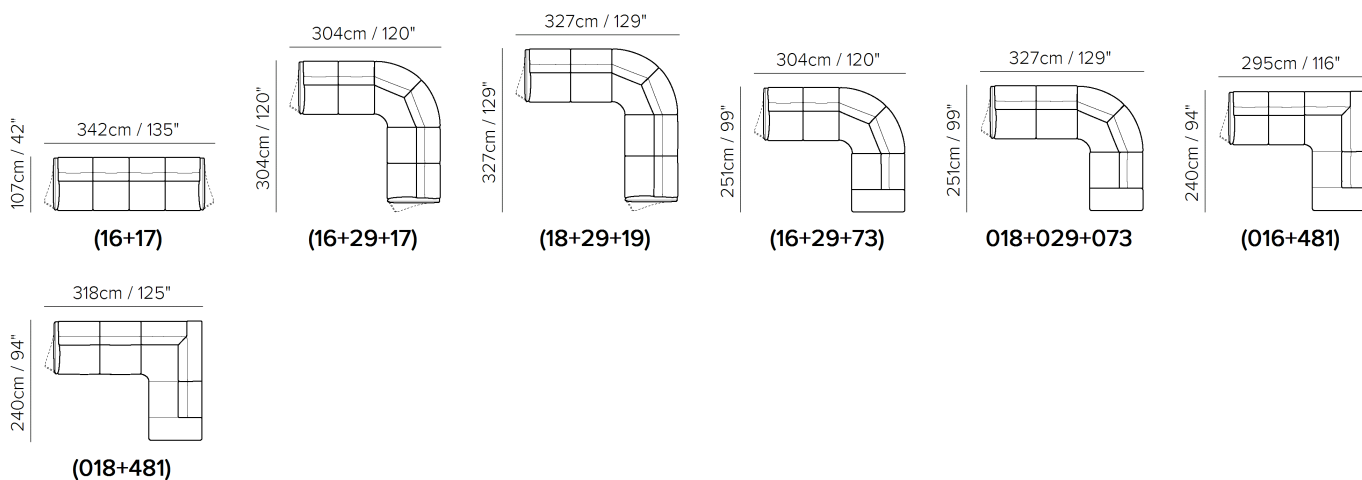

SCHEMATICS



COMPOSITION EXAMPLES



TECHNICAL INFORMATION

	COVERING	Leather <input checked="" type="checkbox"/>	Soft Cover <input checked="" type="checkbox"/>			
	LEGS	Wood <input type="checkbox"/>	Metal <input checked="" type="checkbox"/>	Plastic <input type="checkbox"/>	Castors <input type="checkbox"/>	Upholstered <input type="checkbox"/>
	FILLING	Arms <input type="checkbox"/> Fiber <input checked="" type="checkbox"/> Foam <input type="checkbox"/> Feather/Fiber Mix <input type="checkbox"/> Feather	Seat cushion <input type="checkbox"/> Fiber <input checked="" type="checkbox"/> Foam <input type="checkbox"/> Feather/Fiber Mix <input type="checkbox"/> Feather	Back cushion <input type="checkbox"/> Fiber <input checked="" type="checkbox"/> Foam <input type="checkbox"/> Feather/Fiber Mix <input type="checkbox"/> Feather		
	COMFORT	Standard Comfort <input checked="" type="checkbox"/>	Firm Comfort <input type="checkbox"/>			
	FUNCTION	Bed <input type="checkbox"/>	Electric motion <input type="checkbox"/>	Motion <input type="checkbox"/>	Recliner <input type="checkbox"/>	Sliding <input type="checkbox"/>
	OPTIONS	Nails <input type="checkbox"/>	Removable <input type="checkbox"/>	Contrast Stitching <input type="checkbox"/>		
	WRINKLES & VISUAL APPEARANCE	Low <input type="checkbox"/>	Medium <input checked="" type="checkbox"/>	High <input type="checkbox"/>		

WRINKLES & VISUAL APPEARANCE

Due to a combination of the elasticity of the covering, the nature of the interior construction and the design for comfortability of the product, the model may exhibit differing levels of wrinkles.



The models need to be dressed on a regular basis to maintain their appearance and the wrinkles should not be considered as a manufacturing defect, but a natural characteristic of the product.

NOTES

- In leather, to avoid cuts on the seat and back cushions, the model is available starting from cat. 15; only in article LE MANS
- Model is not available with article Misterbianco (cat. 30).
- Hidden adjustable ratchet in the headrest, for all version except 029/round corner.
- The model has manual adjustable arm and headrest.
- Seat and back cushions in high density polyurethane foam (density 35).
- Tight Seat Cushion (the seat cushions of the models are fixed to the frame)
- Tight Back Cushion (the back cushions of the models are fixed to the frame)
- No Leather Side (the sectional pieces have the side covered with lining and not leather)
- Internal wooden frame
- Without Feet Assembled (the feet will be in a bag inside the package)
- Cardboard Wrap
- Feet available in metal finishings 75 (Glazed Nickel) / 77 (Glossy Chrome)
- Feet height 15,0 cm

NOTES
